

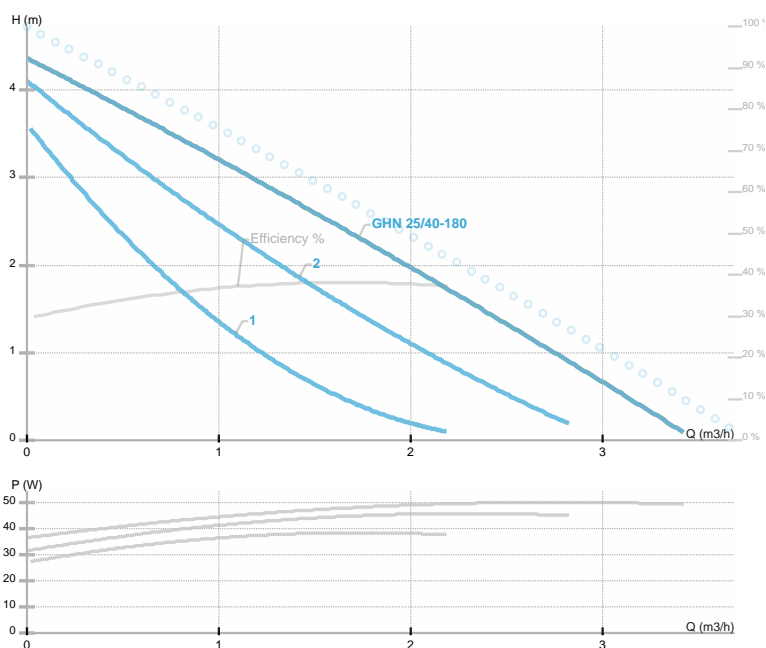

GHN 25/40-180

GHN / Threaded circulation pumps with three speeds
 Heating/cooling, Klimatizacija



Part number	979521710
Power supply	1~230 V
Declared protection	IP44
Q max	3.5 [m³/h]
H max	4.0 [m]
RPM	1315 - 2456 [1/min]
Motor power	50 [w]
Declared current	0.21 [A]
Fluid	Water VDI 2035, glycol 40%
Fluid temperature	-10.0 ÷ 110.0 [°C]
Insulation class	H
DN	25 [mm]
Connector	G 1 ½
Net weight	2.50 [kg]
Length	180 [mm]
Approvals	EAC
EEL	
Efficiency	[%]
Impeller material	Noryl 1630V
Bearing material	Graphite
Shaft material	AISI 420
Hydraulics material	Gray cast iron
Mains frequency	50 Hz
Connection	G 1 ½
Max pressure	1.0 MPa
Ambient temp.range	35 deg C

Dimension drawing

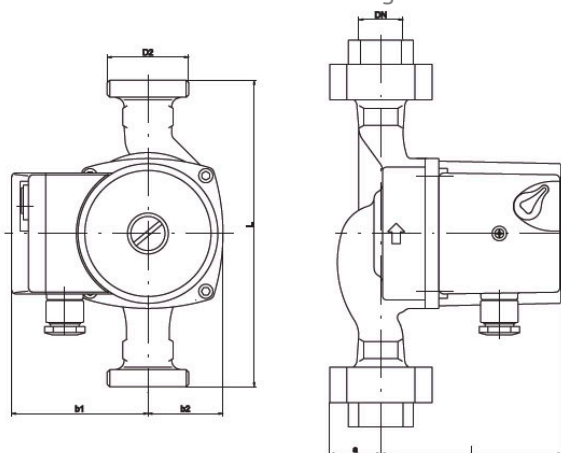

DN=25 D2=1 1/2" L=180 l=108 b1=80 b2=44 a=28

Electrical wiring